



ROCOCO



ROCOCO

Weiming Industrial Zone, Sanzhou, Huangbu Town, Huidong County, Huizhou
City, Guangdong Province, China. Tel.+86-0752-8386168 ext 8013

Website: www.en.rococofloors.com

ROCOCO

The Origin Of Style



Inspired by the 18th century Rococo design spirit, our company strives to continue extending on this original spirit by focusing on:

Creativity

Innovation



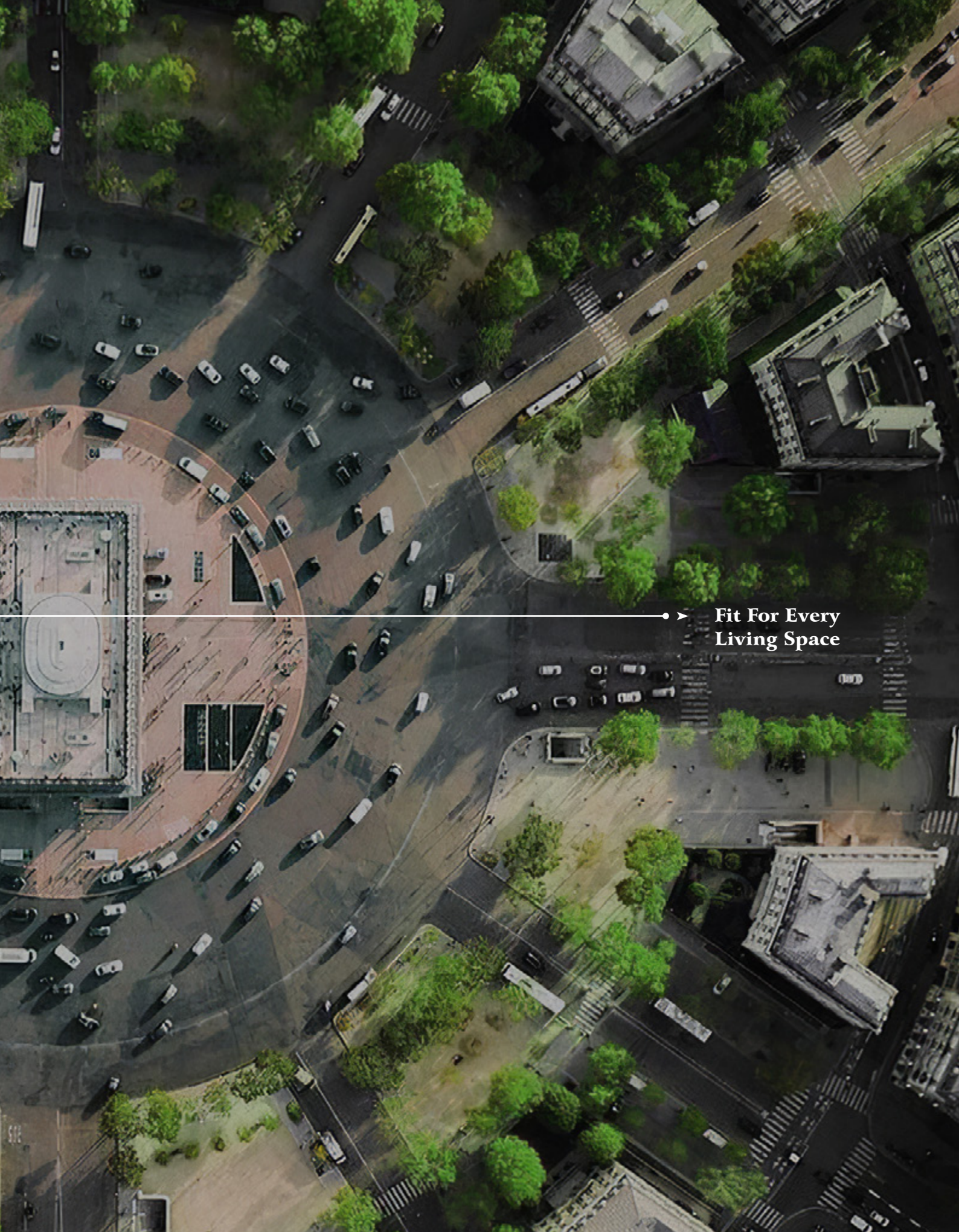

Designs Inspired
By Nature



Fit For Every
Living Space

The Beauty Of Nature



PRODUCTS



LVT
LUXURY VINYL TILES

SPC
STONE POLYMER
COMPOSITE

WPC
WOOD POLYMER
COMPOSITE

SiEx
ACOUSTIC EXPERT

EPC
EXPANDED POLYMER
COMPOSITE

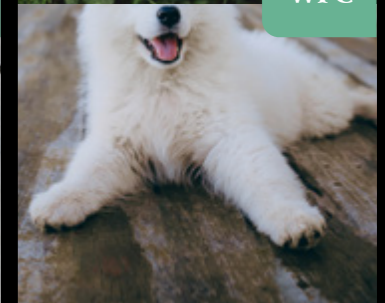
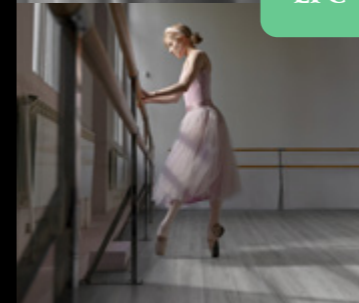

CONTENT

5-6
OUR COLLECTION

9-20
CLASSICO

21-32
ELEGANZA

33-40
EXOTIC WORLD

41-48
RUSTIC CHARM

49-58
NATURALLY STONE

59-72
COLOR CHART

73-75
SURFACE TEXTURE & BEVEL
TREATMENT

76
TECHNICAL DATA



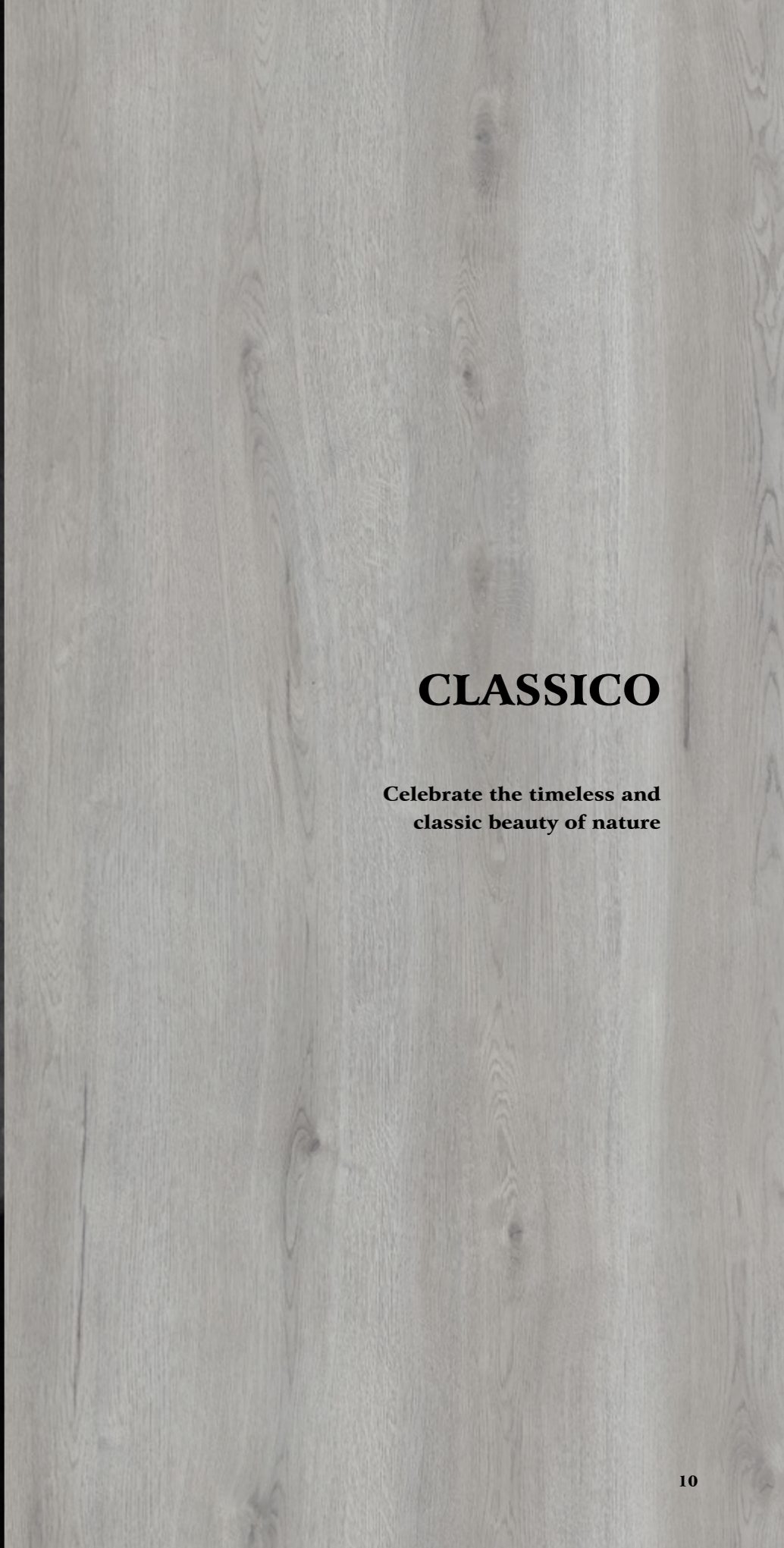

CLASSICO

**Celebrate the timeless and
classic beauty of nature**



CLASSICO

Feel at ease in
the comfort of
nature.

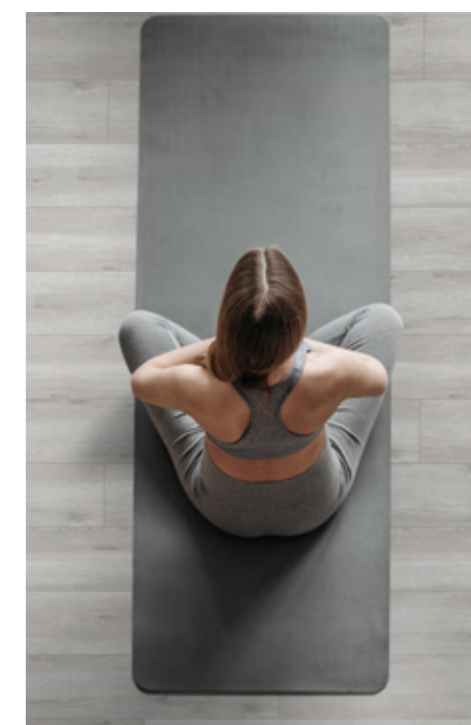

◀ Floor_M0T28 180x1220mm



▲ Floor_M0T31 225×1420mm ○

CLASSICO

Inherits the elegance and
beauty of nature.

▼ Floor_HM0Z31 225×1420mm ●



CLASSICO

—
Bringing nature
into your home.



► Floor_HM0T45 225×1420mm ●



▼ Floor_HM0Q43 225×1420mm





ELEGANZA

The breeze of freshness,
elegance and modern style.



▲ Floor_HM0S88 225×1420mm

ELEGANZA

Sense the calmness and warmth of elegance.



▲ Floor_HM0T01 225×1420mm ●







ELEGANZA

—
Creating a harmonious
living space.



▲ Floor_HM0T22 225×1420mm ●

ELEGANZA

Synchronizing nature with the distinct beauty in geometry and simplicity.

▼ Floor_HM0S89 225×1420mm ●





EXOTIC WORLD

Importing worldwide
natural elements into your
home living environment.



EXOTIC WORLD

Liberate yourself in the comfort of our designed floor mimicking the exotics from all corners of the world .



◀ Floor_M0T19 225×1220mm ●

EXOTIC WORLD

—
Extraordinary colors and patterns creating a unique living environment.



► Floor_M0T20 225×1830mm ●





▲ Floor_HM0S86 225×1420mm ●



RUSTIC CHARM

Evokes the feeling of
pure country living.

RUSTIC CHARM

—
Timeless beauty of a
vintage floor.



Floor_HM0S91 225×1420mm ● ▶



RUSTIC CHARM

▶ Floor_HM0S92 180×1220mm ○



RUSTIC CHARM



◀ Floor_M0T15 225×1420mm ●



NATURALLY STONE

**Natural looking graphic designs
of stone, slate or concrete look.**

--
**Creative styles for individual
simplistic and modern living
spaces.**



NATURALLY STONE

Offers a gray concrete look, provides a successful change of the interior facade.



► Floor_HS0A87 457x935mm





NATURALLY STONE

The concrete element immediately develops a fresh atmosphere in every room.

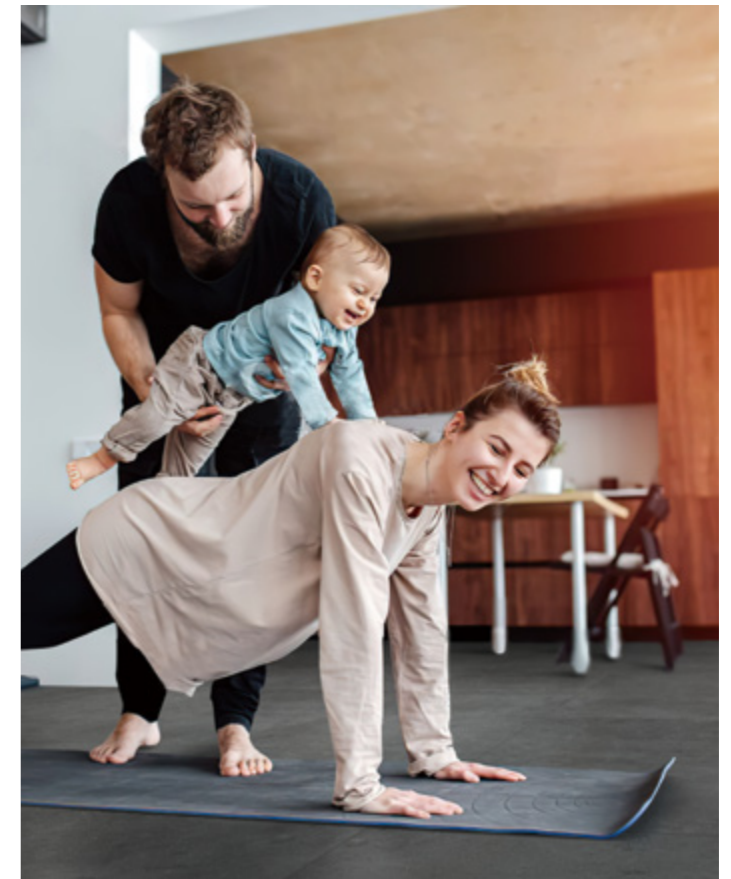

◀ Floor_HS0A83 457x935mm ●



▲ Floor_HS0G13 457×935mm ●



▶ Floor_HS0F07 457×935mm ○



Classico

Unit Measurement: in mm

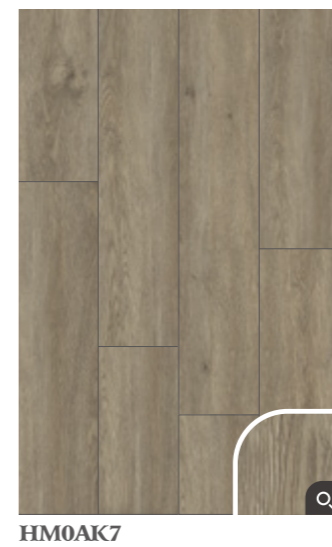
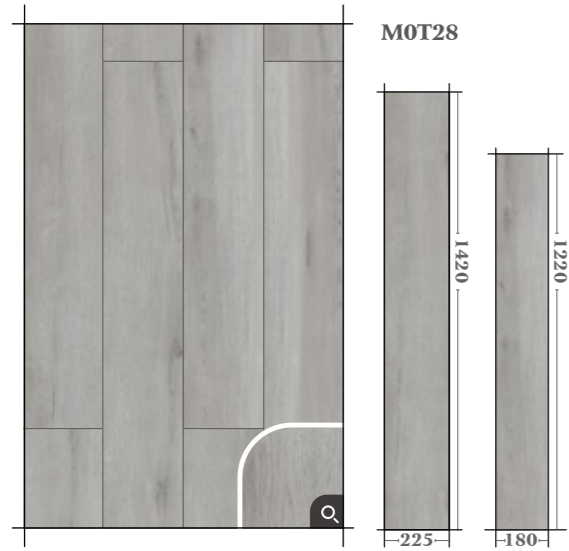

Dry Back size(mm)	Click size(mm)	Graphic presentation
152.4x609.6	120x600	
152.4x914.4	150x935	
184.15x1219.2	180x1220	
228.6x1422.4	225x1420	
228.6x1828.8	225x1820	

ROCOCO



Classico

Unit Measurement: in mm

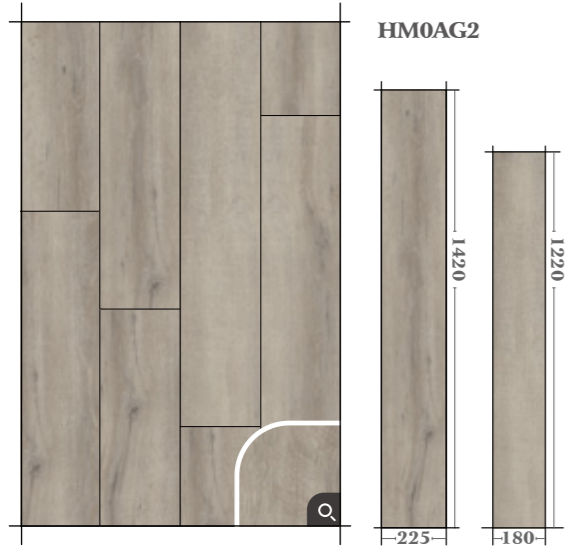

HM0AG2

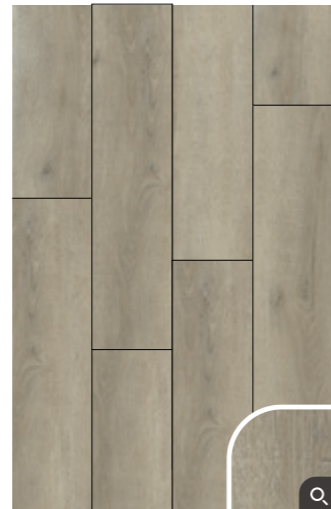

HM0AL0



HM0AG4

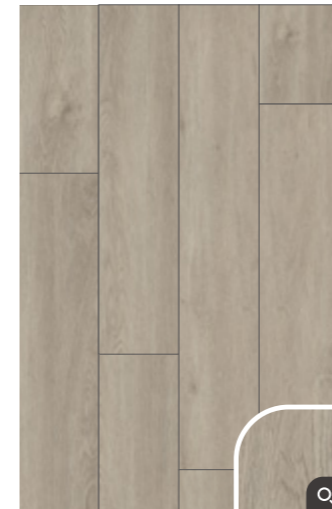

HM0AF6

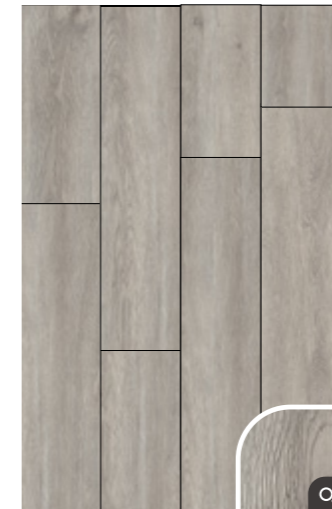

HM0B30

ROCOCO



HM0T45



HM0AB3

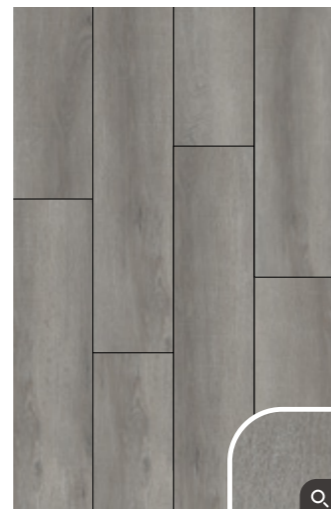

HM0Y78

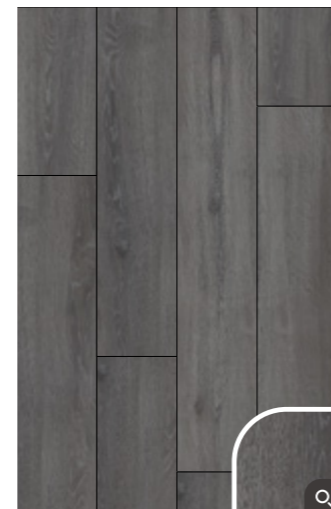

HM0Z30



Classico
HM0AL0

Dry Back size(mm)	Click size(mm)	Graphic presentation
152.4x609.6	120x600	
152.4x914.4	150x935	
184.15x1219.2	180x1220	
228.6x1422.4	225x1420	
228.6x1828.8	225x1820	

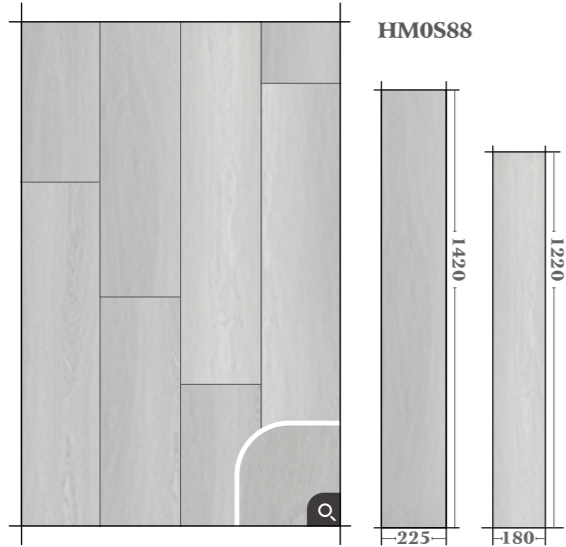

Dry Back size(mm)	Click size(mm)	Graphic presentation
152.4x609.6	120x600	
152.4x914.4	150x935	
184.15x1219.2	180x1220	
228.6x1422.4	225x1420	
228.6x1828.8	225x1820	

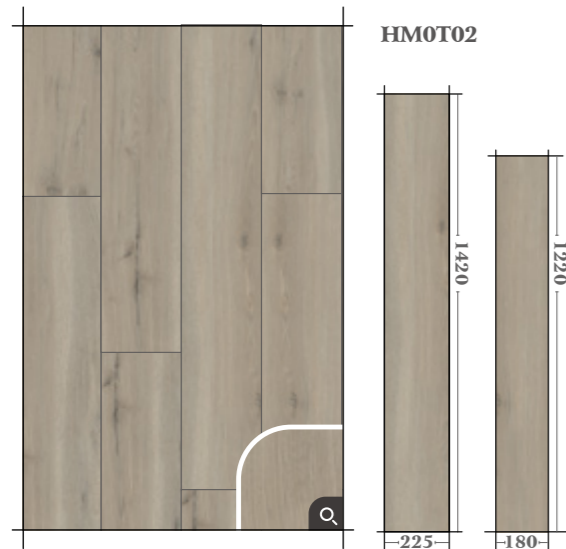

M0T19

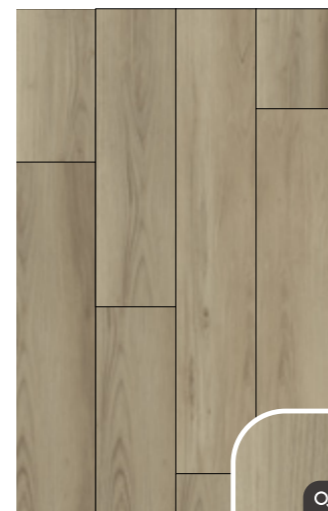

M0T21

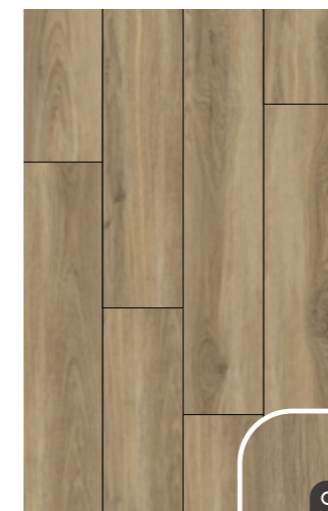

HM0T03

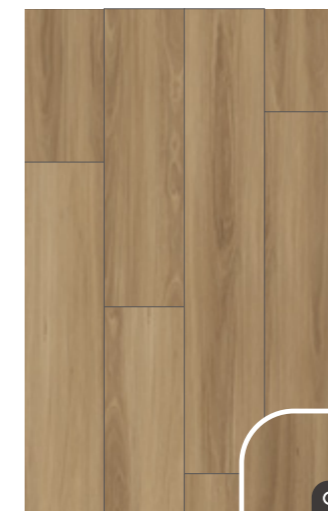

M0T32



M0T11



M0T20

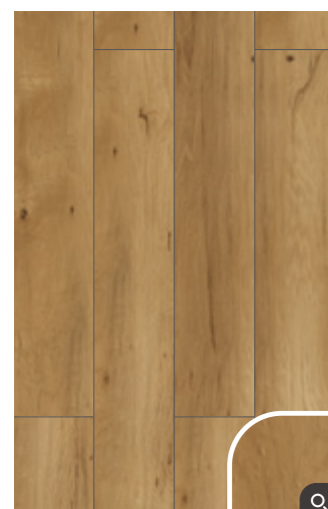

HM0T05

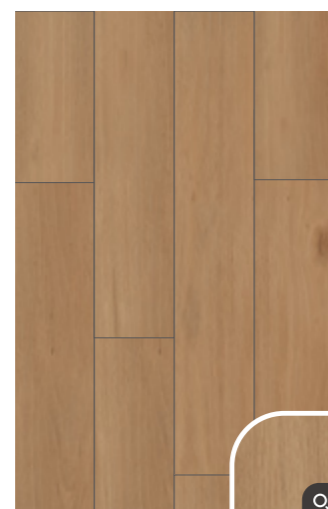

HM0T06

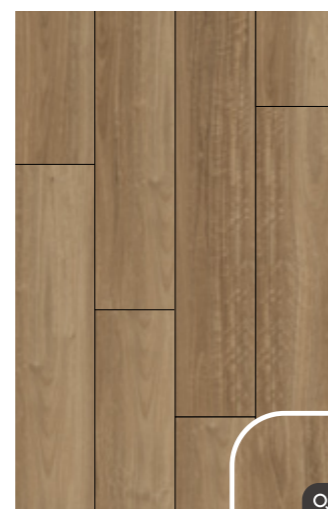

M0T33

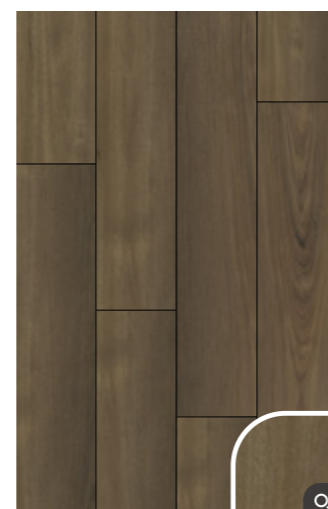

HM0T04

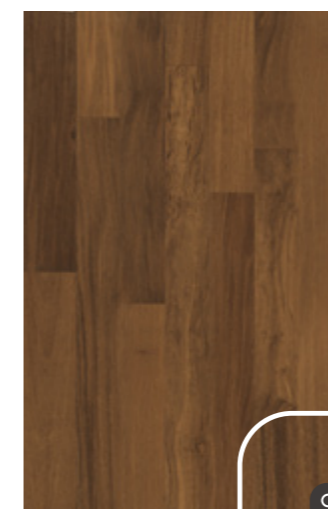

HM0T08

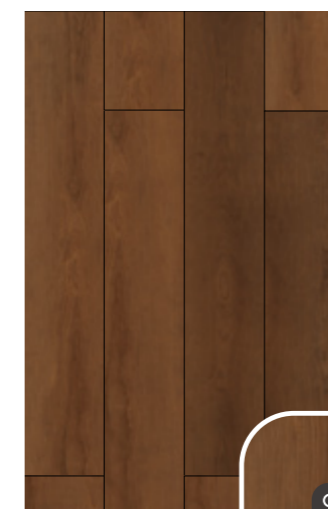

HM0S86

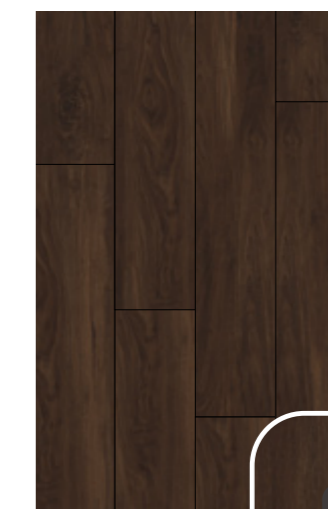

HM0T07

Dry Back size(mm)	Click size(mm)	Graphic presentation
152.4x609.6	120x600	
152.4x914.4	150x935	
184.15x1219.2	180x1220	
228.6x1422.4	225x1420	
228.6x1828.8	225x1820	



Rustic Charm

Unit Measurement: in mm

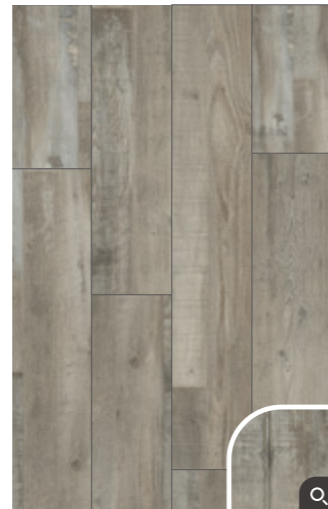

M0T12



HM0W70

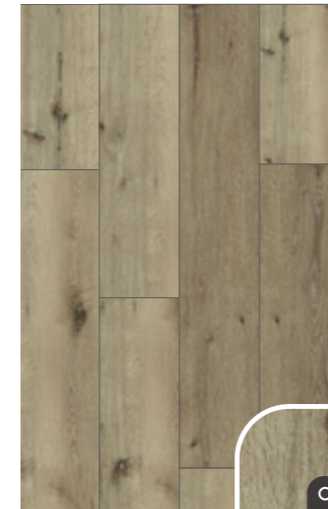

HM0S95



HM0S92

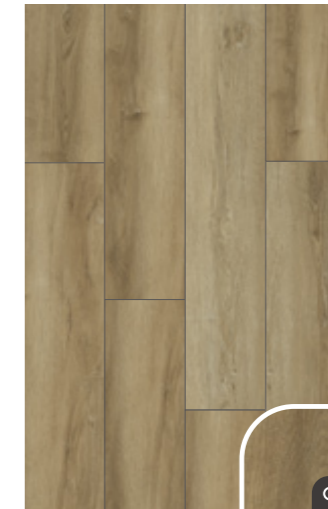

HM0S90



M0T13

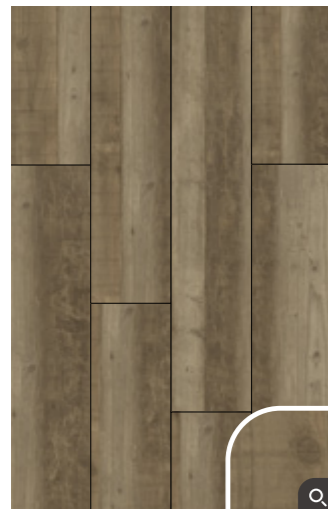

HM0S96

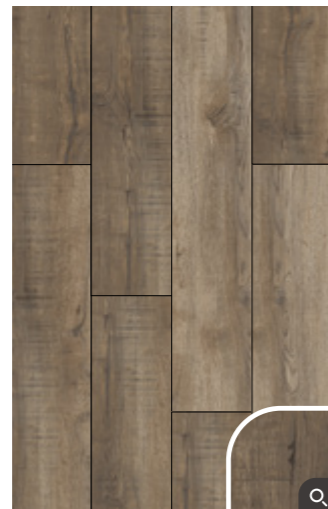

M0T17

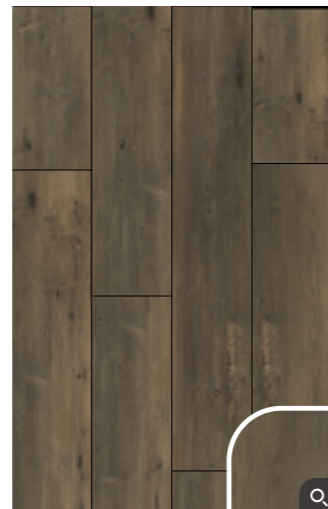

HM0S93

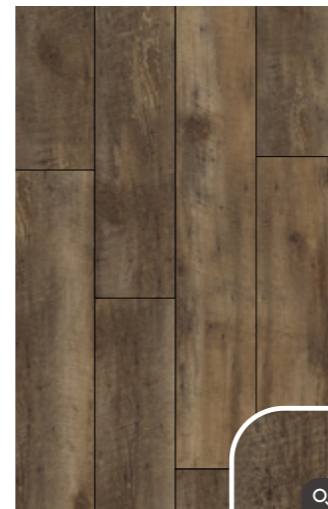

M0T16

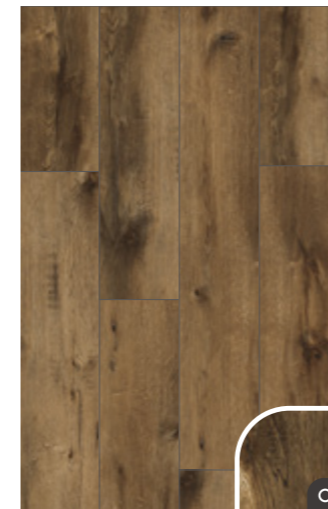

HM0S97

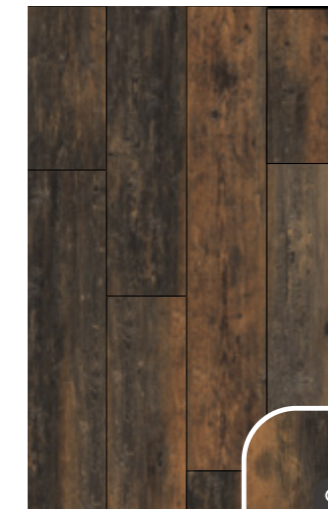

HM0S91

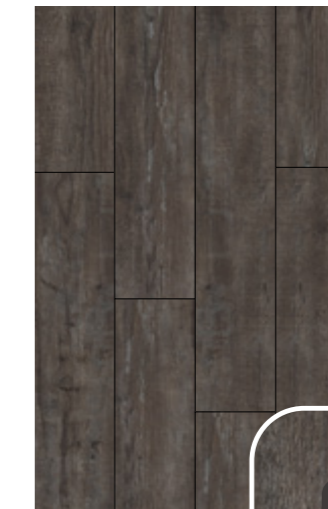

HM0S94



HM0S98

Dry Back size(mm)	Click size(mm)	Graphic presentation
152.4x609.6	120x600	
152.4x914.4	150x935	
184.15x1219.2	180x1220	
228.6x1422.4	225x1420	
228.6x1828.8	225x1820	

ROCOCO



Rustic Charm

Unit Measurement: in mm

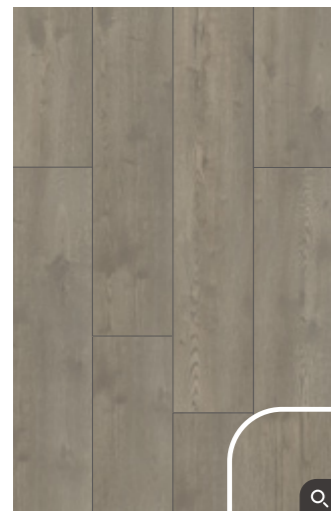

M0T25

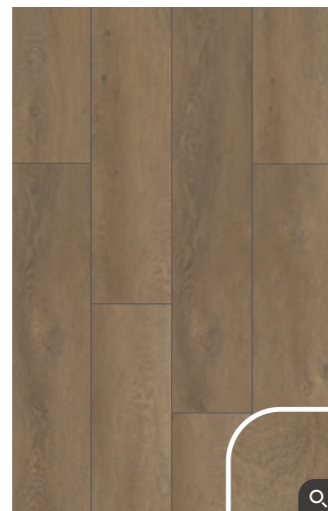

M0T27

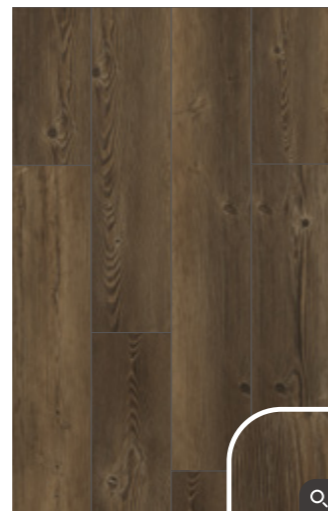

M0T14

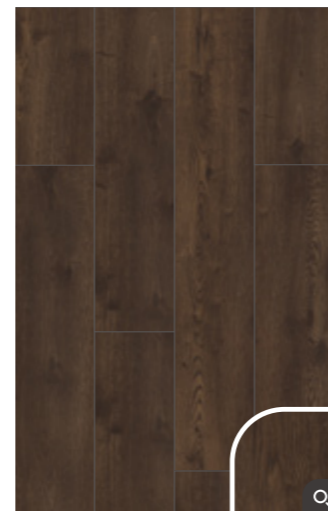

M0T26

Dry Back size(mm)	Click size(mm)	Graphic presentation
152.4x609.6	120x600	
152.4x914.4	150x935	
184.15x1219.2	180x1220	
228.6x1422.4	225x1420	
228.6x1828.8	225x1820	

Rustic Charm

M0T27





Naturally Stone

Unit Measurement: in mm



HS0656

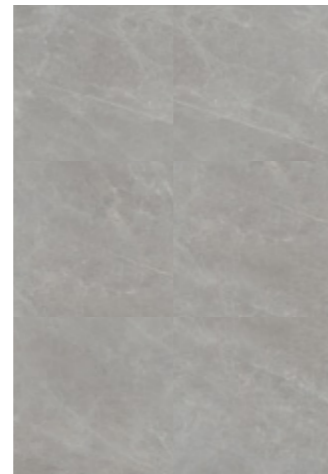
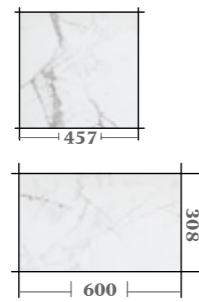

HS0G14

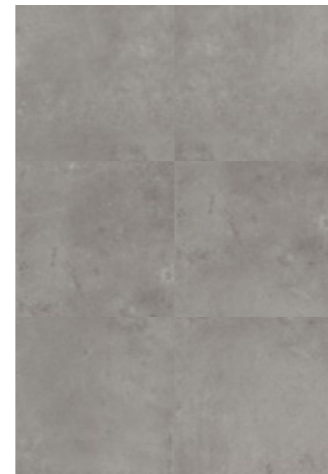

HS0A85



HS0G12



HS0A87



HS0F08



HS0G09



HS0A83

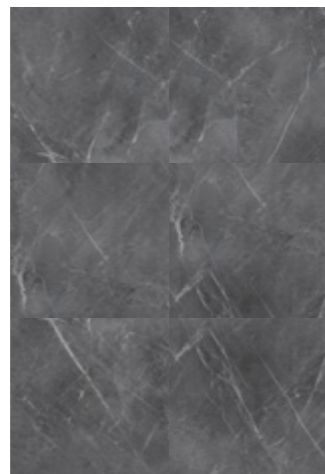

HS0F07

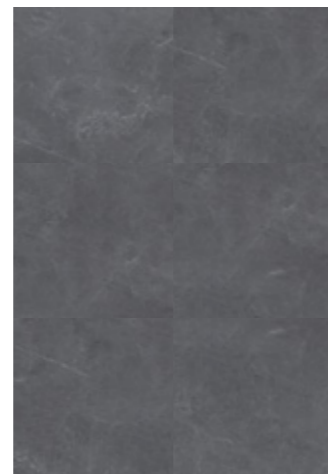

HS0G10



HS0G13

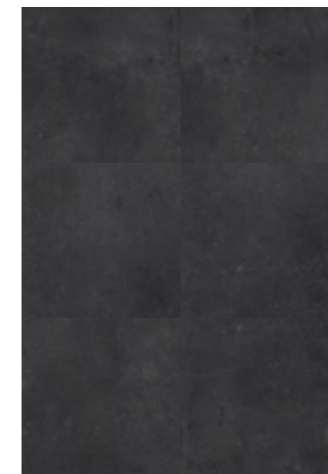

HS0B03



HS0F05

Dry Back size(mm)	Locking Click size(mm)	Graphic presentation
304.8x304.8	308x600	
304.8x609.6	457x600	
457.2x609.6	457x935	
609.6x914.4	600x935	
914.4x914.4	935x935	

ROCOCO

SURFACE TEXTURE EMBOSSING

— Wood & Tiles

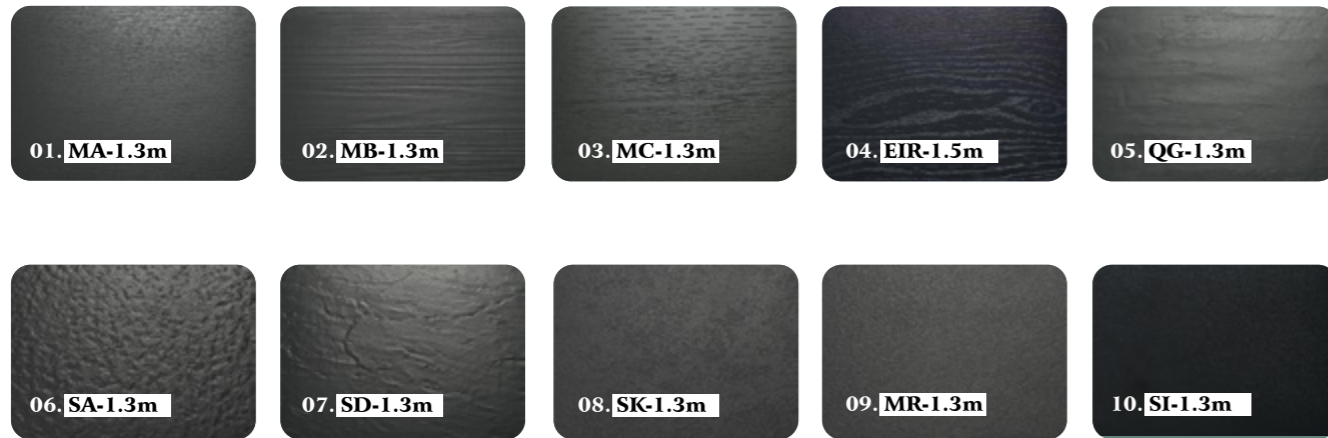

BEVEL TREATMENT

— Wood & Tiles

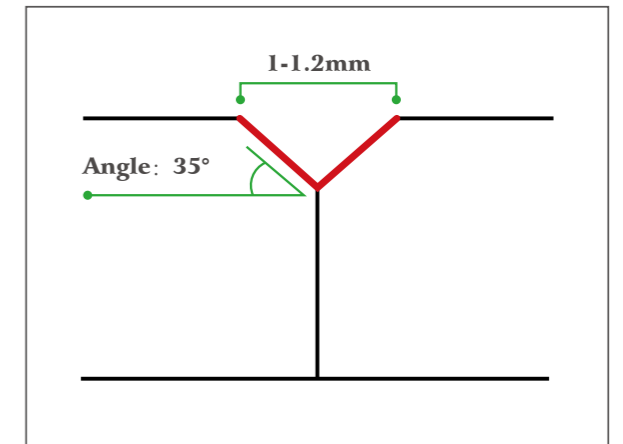
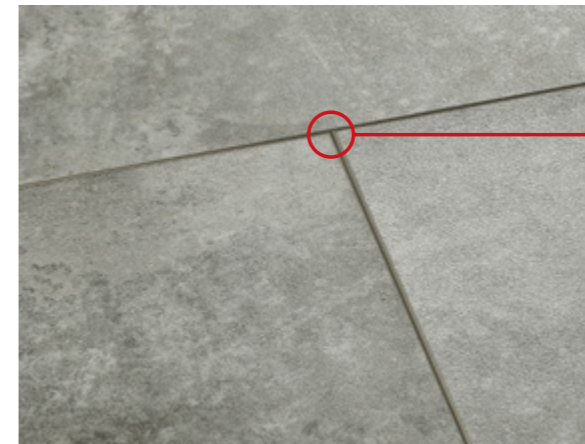

PAINTED BEVEL

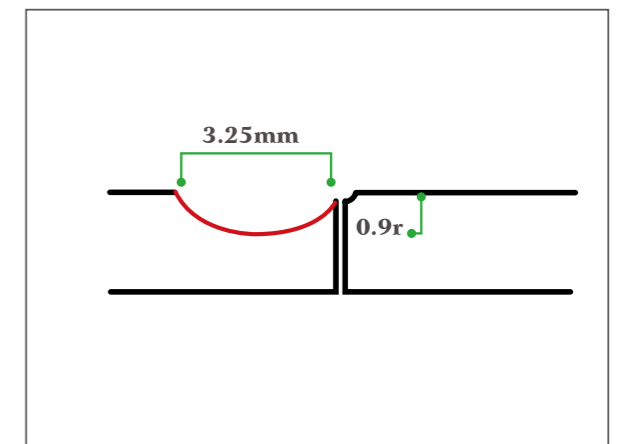
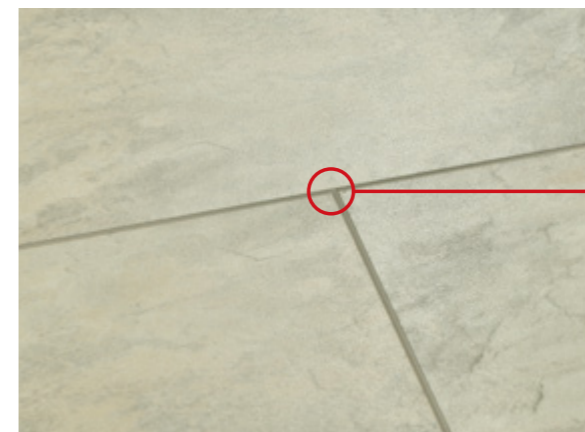

GROUTED PAINTING EDGES

SURFACE TREATMENT

— Wood & Tiles

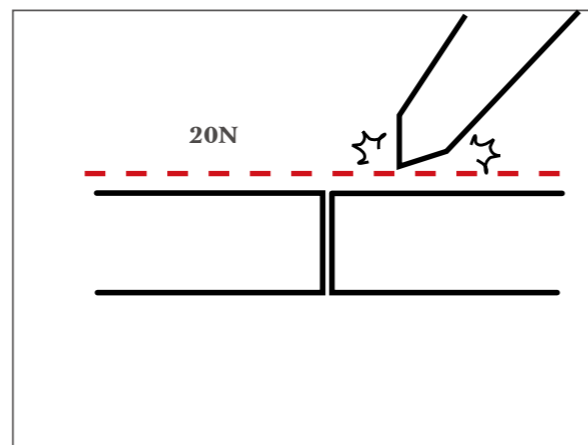

HIGH RESISTANCE TO SCRATCH



ROCOCO

TECHNICAL DATA SHEET

SPECIFICATION	METHO	UNITS	SYMBOL	LVT Dry Back 2.5mm	SPC Click 5.0mm (4.0SPC+1.0IXPE)	WPC Click 6.5mm (1.5LVT+4.0WPC+1.0IXPE)	EPC Click 6.5mm (5.5EPC+1.0IXPE)	SilEx 4.0mm (3.0SiEx+1.0IXPE)
CHARACTERISTICS								
Usage Classification	EN-NF-ISO10874			33 / 42	33 / 42	33 / 42	33 / 42	33 / 42
Dimensions (mm)	EN ISO 24342	mm		152.4*914.4 184.15*1219.2 228.6*1422.4 304.8*609.6 457.2*914.4	149*596 180*1220 225*1420 308*600 457*935	149*596 180*1220 225*1420 308*600 457*935	149*596 180*1220 225*1420 308*600 457*935	152.4*914.4 184.15*1219.2 228.6*1422.4 304.8*609.6 457.2*914.4
Total Thickness	EN ISO 24346	mm		2.5mm	5.0mm	6.5mm	6.5mm	4.0mm
Wear layer thickness	EN ISO 24340	mm		0.55	0.55	0.55	0.55	0.55
Weight/ m2	EN ISO 23997	kg/ m2	N/A	4.44	8.04	7.48	8.9	5.72
Click type	-	-	N/A	/	Välinge 2G/2G	Välinge 2G/5G	Välinge 2G/5G	/
PERFORMANCE								
Abrasion Resistance	EN13329	Pass 4000cycles	N/A	Pass 4000cycles	Pass 4000cycles	Pass 4000cycles	Pass 4000cycles	Pass 4000cycles
Abrasion	EN660-2	group	N/A	T	T	T	T	T
Residual indentation	EN ISO 24343-1	mm		0.04mm	0.08mm	0.08mm	0.08mm	/
Dimensional stability	EN ISO 23999	%		Long side 0.13 % Width 0.11 %	Long side 0.08 % Width 0.06 %	Long side 0.12 % Width 0.1 %	Long side 0.1 % Width 0.08 %	Long side 0.06 % Width 0.05 %
Dimensional stability /curling	EN ISO 23999	mm		0.13% curling:0.25mm	0.08% curling:0.45mm	0.15% curling:0.75mm	0.10% curling:0.5mm	0.06% curling:-0.25mm
Slip restraint	DIN 51130 EN13893			R10 Class DS	R10 Class DS	R10 Class DS	R10 Class DS	R10 Class DS
Wear Chemical resistance	EN ISO 26987			Not affected	Not affected	Not affected	Not affected	Not affected
Colour fastness to light	EN ISO 105-B02			6	6	6	6	6
Flammability / Smoke emissions	EN13501-1			Bfl-S1	Bfl-S1	Bfl-S1	Bfl-S1	Bfl-S1
Castor chair Resistance (Type W)	ISO 4918:2009	Cycles		Pass(25000r)	/	Pass(25000r)	Pass(25000r)	Pass(25000r)
Impact sound insulation ΔLw	ISO 712-2	DB		/	19	19	19	19
Thermal resistance	EN 12667			0.035(m2 • k)/w	0.047(m2 • k)/w	0.052(m2 • k)/w	0.052(m2 • K)/W	0.042(m2 • k)/w
Electrostatic performance	EN 1815	kV	N/A	≤ 2.0kv	≤ 2.0kv	≤ 2.0kv	≤ 2.0kv	≤ 2.0kv
Lock strength	ISO24334			/	3Kn/m	3Kn/m	3Kn/m	/
Surface treatment	-	-	N/A	UV/Acrylate UV	UV/Acrylate UV	UV/Acrylate UV	UV/Acrylate UV	UV/Acrylate UV
Underfloor heating suitability	EN 12524			Max.27 °C	Max.27 °C	Max.27 °C	Max.27 °C	Max.27 °C
ENVIRONMENT								
TVOC After 28 days (AgBB test)	ISO 16000-9		N/A	11	11	11	11	11
Formaldehyde group	EN 717-1	class		E1	E1	E1	E1	E1
Plasticizer components	EN14372			100% Virgin PVC	100% Virgin PVC	100% Virgin PVC	100% Virgin PVC	100% Virgin PVC
WARRANTY								
Warranty Residential			N/A	25	25	25	25	25
Warranty Commercial			N/A	10	10	10	10	10

